



KEMPER[®]
echo™

FULL LINE BROCHURE



KEMPER[®]
echo™

MORE FOR LESS

You don't need a fat wallet to get inviting style and serious function. That's because Kemper[®] Echo™ gives you more for less. You'll find more storage-stretching organizers, with cabinets that push capacity to the max, which means less wasted space. You'll welcome more personality and less ho-hum, from the overall look to the details like glass and hardware. And you'll garner more confidence and less doubt with cabinetry that is precision-made of quality materials backed by Kemper's Limited Lifetime Warranty. Kemper Echo – get used to more.

- 02 Kitchen Spaces
- 28 Other Rooms
- 34 Mouldings & Embellishments
- 36 Storage Solutions
- 39 Lighting
- 40 Door Styles
- 47 Finishing Touches
- 48 Finishes
- 50 Construction



ANTRIM
HICKORY : RIVERWOOD



1.



2.



3.

- 1. ISLAND WITH OPEN CABINET
- 2. TABLET HOLDER
- 3. BASE CORNER CABINET WITH PULLOUT



TRILLIAN
LAMINATE : ALABASTER

WARREN
PURESTYLE™ : LIMESTONE



1.



2.



3.

1. WALL VERTICAL LIFT CABINET
2. 6" WIDE FULL HEIGHT BASE CABINET
3. TWO-DRAWER 48" WIDE BASE CABINET



WOLCOTT
CHERRY : TUSCAN



- 1. OVEN CABINET WITH DEEP DRAWER
- 2. TWO DRAWER BASE CABINET WITH ROLL TRAY
- 3. FULL HEIGHT BASE WASTEBASKET CABINET*

*CABINET DESIGN HAS BEEN ENHANCED FOR IMPROVED PERFORMANCE, (SHOWN ON PAGE 55). REQUEST ADDITIONAL INFORMATION FROM YOUR DEALER.



MARIMAC
MAPLE : BRIE



1.



3.



2.



4.

- 1. SINK BASE CABINET WITH CLEANING CADDY
- 2. WALL SPICE PULL-OUT CABINET
- 3. BASE EASY REACH CABINET
- 4. POWER POD

LORETTO

CHERRY : SANDSTONE



1. DOUBLE BASE WASTEBASKET CABINET*
2. WALL TOP HINGE CABINET
3. COOKING UTENSIL DIVIDER

*CABINET DESIGN HAS BEEN ENHANCED FOR IMPROVED PERFORMANCE, (SHOWN ON PAGE 55). REQUEST ADDITIONAL INFORMATION FROM YOUR DEALER.



TEAGUE
 PURESTYLE™: ALABASTER



1.



2.



3.



4.

- 1. OPEN CABINET WITH GLASS SHELVES
- 2. BASE CABINET WITH ROLL TRAYS
- 3. LIGHT BAFFLE MOULDING WITH ART CORBEL
- 4. COUNTRY SINK BASE CABINET WITH ANGLED FURNITURE TOEKICK VALANCE



MORIARTY

MAPLE : DARK ALE & ALABASTER WITH BROWN SUGAR GLAZE



1.



3.

- 1. WOOD HOOD CANOPY ARCH
- 2. WALL MESSAGE CENTER CABINET
- 3. ART CORBEL



EKSTEN

MAPLE : LIMESTONE WITH BROWN SUGAR GLAZE
CHERRY : AMBER SUEDE WITH BROWN SUGAR GLAZE

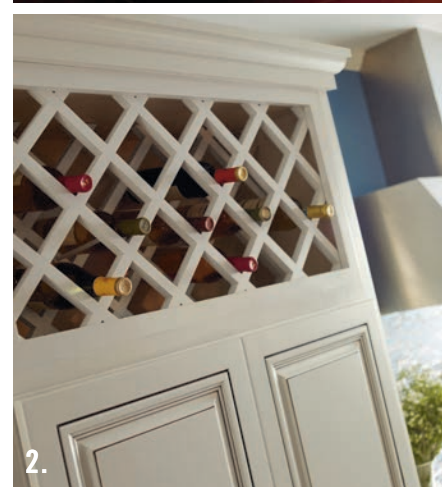

- 1. BASE CABINET WITH ROLL TRAYS
- 2. WALL WINE RACK CABINET
- 3. MISSION ROSETTE



HYDE

CHERRY : AMBER SUEDE

MAPLE : ALABASTER WITH BARN WOOD GLAZE



1. MISSION LEG

2. BASE TRAY DIVIDER CABINET

3. BASE PANTRY PULLOUT CABINET



CROSBY
CHERRY : DARK ALE



1.



2.

- 1. WALL CABINET WITH CUT FOR GLASS DOORS
- 2. FURNITURE DRAWERS



WOLCOTT
MAPLE : LIMESTONE



1.



2.



3.

1. WALL MICROWAVE CABINET
2. TOEKICK DRAWER WITH PUSH-TO-OPEN GUIDES
3. SINK BASE CABINET WITH CABMAT™



SULTAN
OAK : BARLEY



1. BASE SUPER LAZY SUSAN CABINET
2. TULIP FOOT
3. LIGHT RAIL MOULDING
4. TAPERED WOOD HOOD



ROYER
PURESTYLE™: BLUFF



- 1. WALL VANITY MIRROR WITH CUT FOR GLASS DOOR AND INSTALLED MIRROR
- 2. TILT-OUT TRAY
- 3. LINEN CLOSET CABINET WITH REMOVABLE HAMPER



TARVER

OAK : DARK ALE



- 1. COVE CROWN MOULDING
- 2. UTILITY CABINET WITH ROLL TRAYS
- 3. METRO ISLAND COLUMN



BERG
PURESTYLE™: SCONE



1. TALL CROWN MOULDING
2. CUT FOR GLASS DOOR

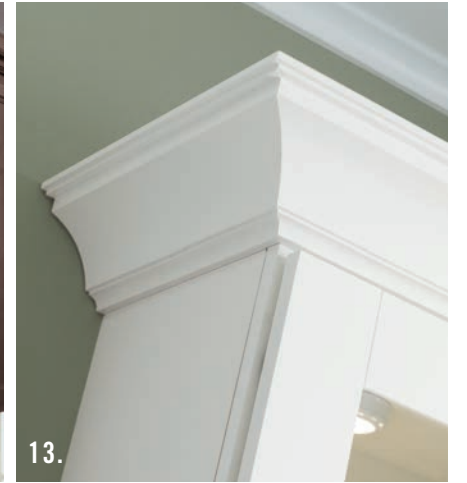

MOULDINGS & EMBELLISHMENTS

- 1. MISSION ROSETTE
- 2. MISSION LEG
- 3. SHAKER CROWN MOULDING
- 4. WALL WINE RACK CABINET
- 5. TULIP FOOT

- 6. FLOATING SHELVES
- 7. ART CORBEL
- 8. WALL TOP HINGE CABINET
- 9. SNACK BAR SUPPORT
- 10. LILLE FOOT

- 11. ARCHED CANOPY WOOD HOOD
- 12. METRO BAR COLUMN
- 13. CORNICE TALL CROWN MOULDING
- 14. WOOD HOOD SQUARE
- 15. BEADED BASEBOARD MOULDING



STORAGE SOLUTIONS

- 1. BASE DOUBLE WASTEBASKET* CABINET
- 2. COOKING UTENSIL DIVIDER
- 3. WALL APPLIANCE GARAGE CABINET
- 4. BASE UTENSIL PANTRY PULLOUT CABINET

- 5. SINK BASE CLEANING CADDY
- 6. LINEN CLOSET WITH REMOVABLE HAMPER
- 7. CABMAT™
- 8. SCOOPED DRAWER MODIFICATION

- 9. 30" SUPERCABINET™
- 10. UTILITY ORGANIZER CABINET
- 11. WALL MESSAGE CENTER
- 12. BASE SUPER LAZY SUSAN

*CABINET DESIGN HAS BEEN ENHANCED FOR IMPROVED PERFORMANCE, (SHOWN ON PAGE 55). REQUEST ADDITIONAL INFORMATION FROM YOUR DEALER.

LIGHTING

1. LED Rigid Strip
2. LED Puck Light
3. LED Flexible Strip
4. Quattro Zoned Lighting Controller*

*Create and control up to four separate lighting zones in your space with Quattro Lighting.



STORAGE SOLUTIONS

- | | | |
|---|--|--|
| <ol style="list-style-type: none"> 1. VANITY WALL MIRROR WITH CUT FOR GLASS DOOR AND INSTALLED MIRROR 2. SINK BASE SUPERCABINET™ WITH CABMAT™ | <ol style="list-style-type: none"> 3. POWER POD 4. TOEKICK DRAWER 5. TALL PANTRY PULL-OUT CABINET | <ol style="list-style-type: none"> 6. TWO DRAWER 48" WIDE BASE CABINET 7. WALL VERTICAL LIFT CABINET |
|---|--|--|

DOOR STYLES

MAPLE



Antrim
partial overlay



Berg
partial overlay

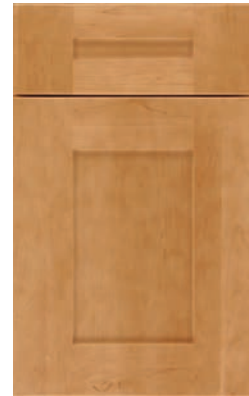

Crosby
full overlay



Crosby
full overlay
slab drawer front option



Eksten
full overlay

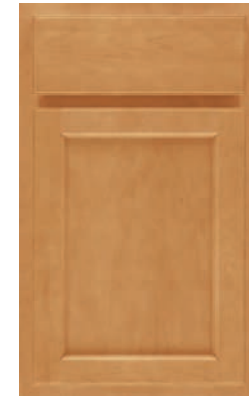

Tarver
partial overlay



Tolono
full overlay

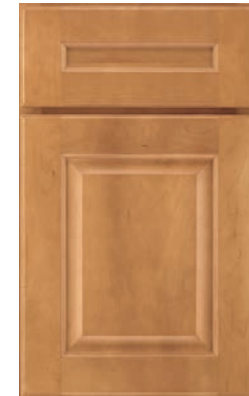

Tolono
full overlay
5-piece drawer front option

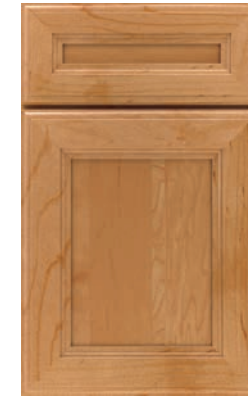

Warren
full overlay



Wolcott
full overlay



Hyde
partial overlay



Loretto
full overlay



Marimac
full overlay

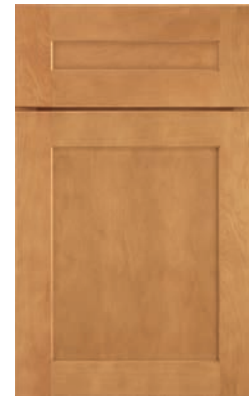

Marimac
full overlay
5-piece drawer front option



Moriarty
partial overlay

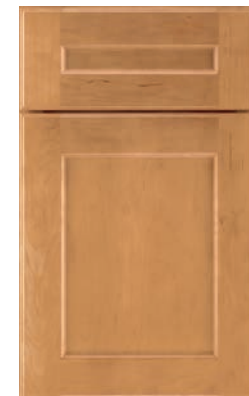

Wolcott
full overlay
5-piece drawer front option



Moriarty
partial overlay
5-piece drawer front option



Napa
partial overlay



Royer
full overlay



Royer
full overlay
5-piece drawer front option



Sultan
full overlay

DOOR STYLES

CHERRY



Antrim
partial overlay



Berg
partial overlay



Crosby
full overlay



Crosby
full overlay
slab drawer front option



Eksten
full overlay



Tarver
partial overlay



Tolono
full overlay



Tolono
full overlay
5-piece drawer front option



Warren
full overlay



Wolcott
full overlay



Hyde
partial overlay



Loretto
full overlay



Marimac
full overlay



Marimac
full overlay
5-piece drawer front option



Moriarty
partial overlay



Wolcott
full overlay
5-piece drawer front option



Moriarty
partial overlay
5-piece drawer front option



Napa
partial overlay



Royer
full overlay



Royer
full overlay
5-piece drawer front option



Sultan
full overlay

DOOR STYLES

OAK



Antrim
partial overlay



Hyde
partial overlay



Moriarty
partial overlay



Moriarty
partial overlay
5-piece drawer front option



Napa
partial overlay



Sultan
full overlay



Tarver
partial overlay



Tolono
full overlay



Tolono
full overlay
5-piece drawer front option



Wolcott
full overlay



Wolcott
full overlay
5-piece drawer front option

DOOR STYLES

HICKORY



Antrim
partial overlay

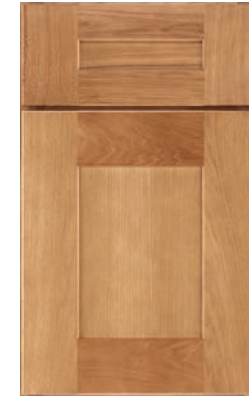

Crosby
full overlay

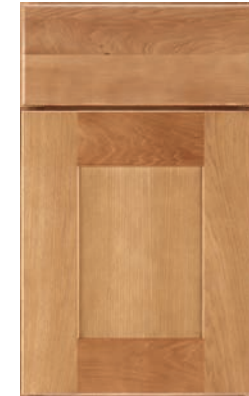

Crosby
full overlay
slab drawer front option

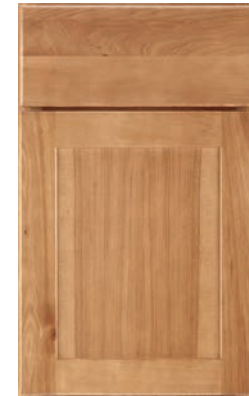

Marimac
full overlay



Marimac
full overlay
5 piece drawer front option



Napa
partial overlay



Sultan
full overlay



Tarver
partial overlay

DOOR STYLES

PURESTYLE™ AND LAMINATE*



Berg
partial overlay



Crosby
full overlay



Crosby
full overlay
slab drawer front option



Marimac
full overlay



Marimac
full overlay
5 piece drawer front option



Moriarty
partial overlay



Royer
full overlay



Royer
full overlay
5 piece drawer front option



Teague
full overlay



Trillian*
full overlay



Warren
full overlay

FINISHING TOUCHES

TEXTURED GLASS INSERTS



Antique



Bevel

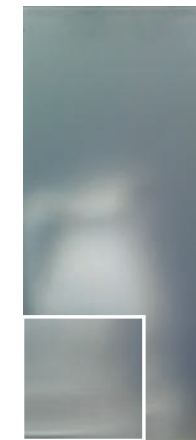

Frost



Reeded

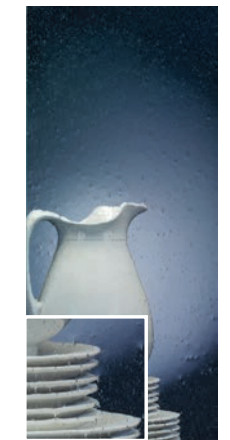

Seeded

Clear glass also available

HARDWARE



FINISHES

* The door and/or drawer front center panel may be constructed of Medium Density Fiberboard (MDF).
 ◊ Unfinished also available.

MAPLE

STANDARD FINISHES◊



BARN WOOD GLAZE



BROWN SUGAR GLAZE



OPAQUES*

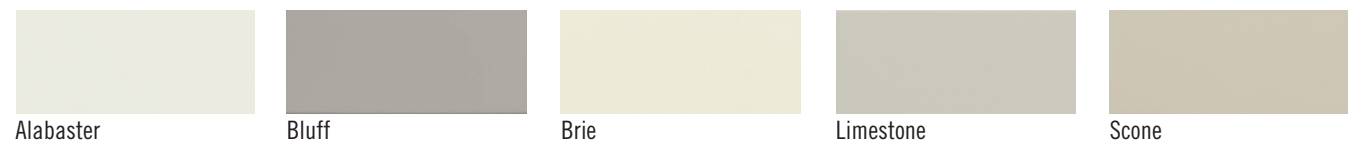

BARN WOOD GLAZE*



BROWN SUGAR GLAZE*



HICKORY

STANDARD FINISHES◊

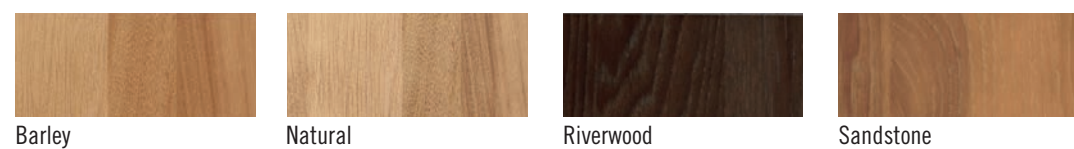

BARN WOOD GLAZE

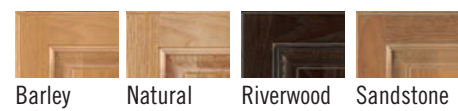

BROWN SUGAR GLAZE



CHERRY

STANDARD FINISHES◊



BARN WOOD GLAZE



BROWN SUGAR GLAZE



OAK

STANDARD FINISHES◊



BARN WOOD GLAZE



BROWN SUGAR GLAZE



PURESTYLE™ AND LAMINATE

STANDARD FINISHES



CONSTRUCTION

STANDARD CABINET

- 3/8" Furniture board end panels
- 1/2" Furniture board top and bottom
- 1/2" I-beam braces dadoed into face frame, end panels and back
- 3/8" Furniture board integrated back
- 3/4" Solid hardwood face frame
- Fully concealed, 6-way adjustable hinge
- Cabinet interior laminated natural maple or white



STANDARD DRAWER

- 3/4 extension, side-mounted, epoxy-coated guides
- 1/2" laminated furniture board sides; 3/8" bottom



ROLL TRAY OPTIONS



STANDARD FURNITURE BOARD ROLL TRAYS

- 3/4 extension, side-mount guides
- 3/8" natural maple laminated furniture board bottom
- 1/2" natural maple laminated furniture board sides



UPGRADE SOLID WOOD DOVETAIL ROLL TRAYS WITH SMART STOP™ (SP)

- Smart Stop™ full extension guides
- 4-sided, clear-coated, solid wood
- 3/4" nominal thick dovetail sides with 5.2mm laminated plywood* bottom

CABINET BOX OPTIONS



UPGRADE 1

ALL PLYWOOD* WITH LAMINATE ENDS (KPL)

- All standard features. Replaces standard cabinet construction with plywood
- 3/8" Plywood end panels and back
- 1/2" Plywood top, bottom, and I-beam braces
- Exterior end panels laminated to match the selected finish



UPGRADE 2

ALL PLYWOOD* WITH FINISHED ENDS (KPF)

- All standard features. Replaces standard cabinet construction with plywood
- 3/8" Plywood end panels and back
- 1/2" Plywood top, bottom, and I-beam braces
- Finished veneer exterior end panels to match the selected finish



UPGRADE 3

FURNITURE FINISHED PLYWOOD* END PANELS (FPEB)

- All standard features. Replaces standard 3/8" end panels with 3/4" plywood
- Finished veneer exterior end panels to match the selected finish

SMART STOP™ UPGRADES



DRAWER UPGRADE

SOLID WOOD DOVETAIL DRAWER WITH FULL EXTENSION GUIDE WITH SMART STOP™ (PG)

- Full extension, undermount guides with Smart Stop™ and fast-clip removal system
- 4-sided, clear-coated, solid wood drawer box
- 3/4" nominal thick dovetail sides with 5.2mm laminated plywood* bottom

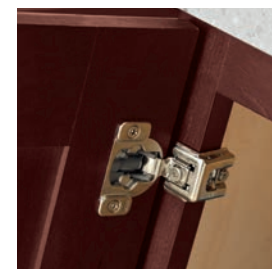

DOOR HINGE UPGRADE

SMART STOP™ CABINET DOOR HINGE (INTGH)

- This innovative hinge provides a gentle, controlled self-closing feature that engages when the door nears the cabinet face frame.

SHELF OPTIONS



STANDARD FURNITURE BOARD SHELVES

- 3/4" adjustable furniture board shelving



UPGRADE PLYWOOD SHELVES*

- All standard features. Replaces standard shelves with laminated plywood shelves
- Must upgrade to all plywood construction (KPL or KPF)

* All plywood components meet ANSI/HPVA HP-1 standards, and may contain MDF or particleboard.

* All plywood components meet ANSI/HPVA HP-1 standards, and may contain MDF or particleboard.



Environmental Stewardship Program
All products respect the environment.
For ESP program criteria, visit greenkitchen.org

WALL STORAGE

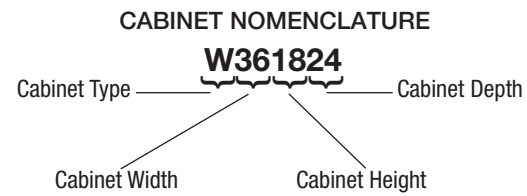

The cabinets listed below, and in the following pages, represent a sampling of our most popular cabinets. See your kitchen and bath designer for our full-line of cabinets and their specifications.

Here are some things to keep in mind when choosing your cabinets:
For Single Door Cabinets, specify L or R hinging.

Standard Depths and Heights (unless otherwise noted):

- Wall Cabinet Depth is 12".
- Base Cabinet Depth is 24", Height 34 1/2".
- Tall Cabinet Depth is 12" or 24".
- Vanity Cabinet Depth is 18" or 21", Height 32" or 34 1/2".

CUT FOR GLASS SPECIALTY DOORS*

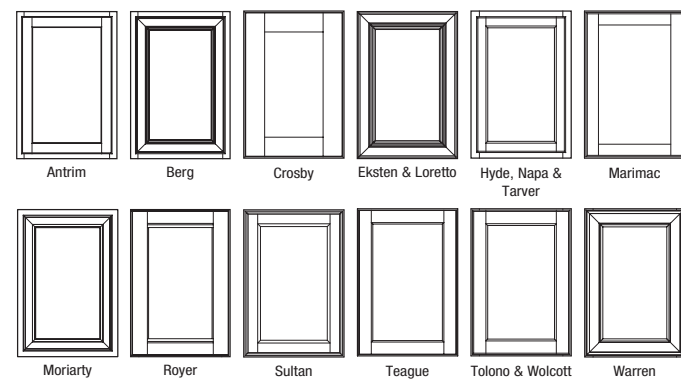

*Glass not included, but available to order separately.

MULLION SPECIALTY DOORS*

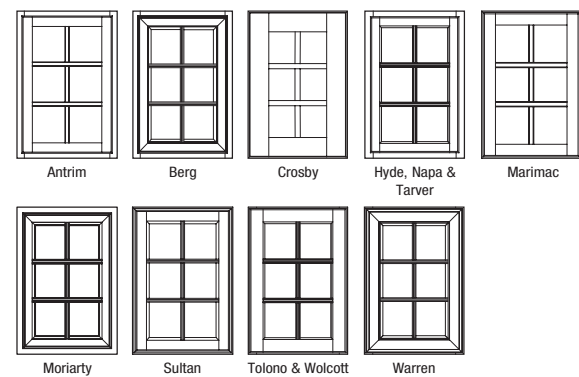

*Glass not included, but available to order separately.

WALL SINGLE DOORS

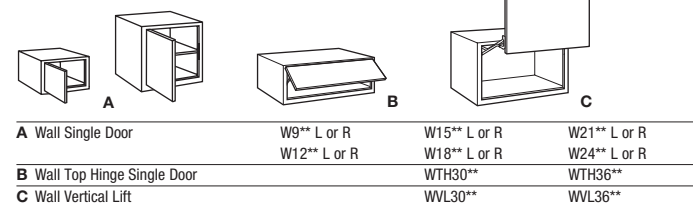

Note: The number of shelves varies with the height. The number of drawers varies with the width. This represents a portion of the entire line. See your kitchen designer for the full line offering.

WALL AND BASE STORAGE

WALL DOUBLE DOORS

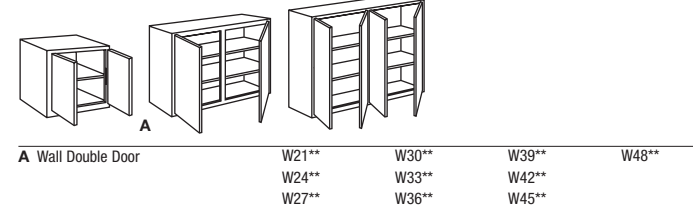

WALL REFRIGERATOR OPTIONS

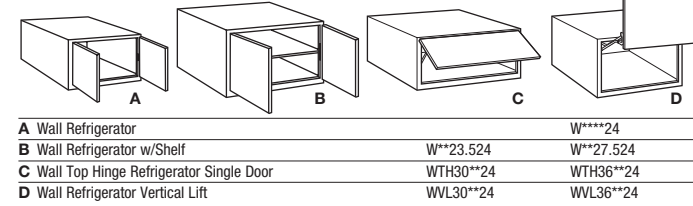

WALL THREE DRAWER

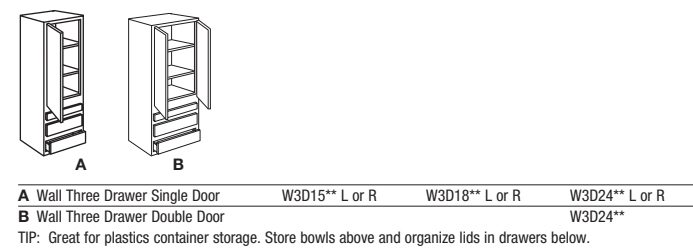

WALL CORNER OPTIONS

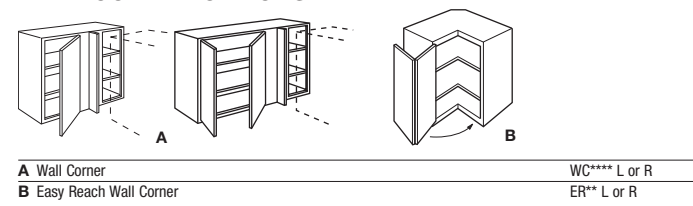

DIAGONAL WALL CABINETS

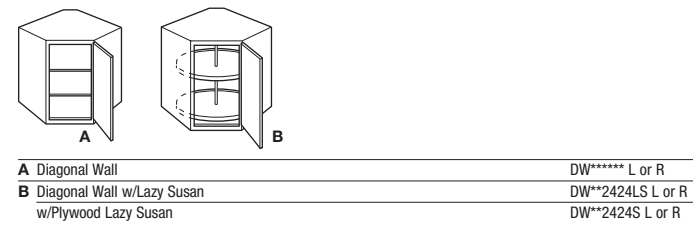

WALL END OPTIONS

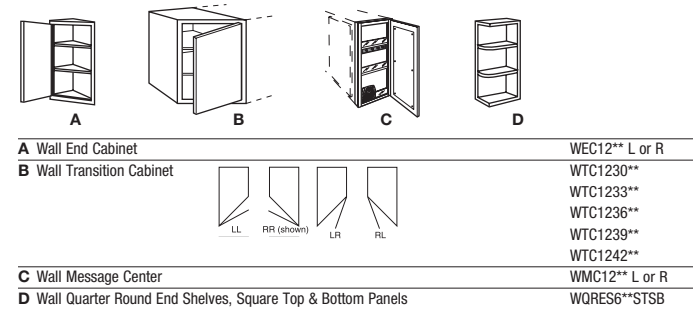

WALL MICROWAVE CABINETS

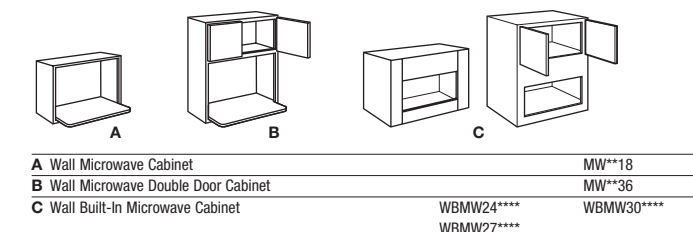

WALL SPICE RACKS/ORGANIZERS

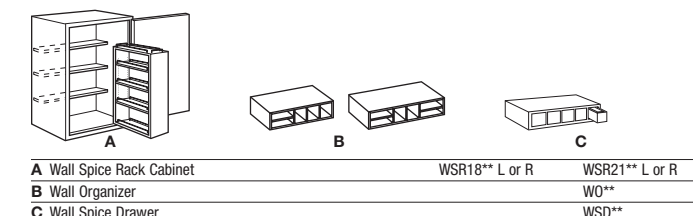

WALL APPLIANCE GARAGE/CORNER DOOR

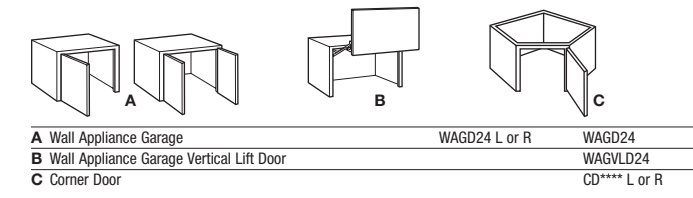

WALL/BASE PULL-OUT STORAGE

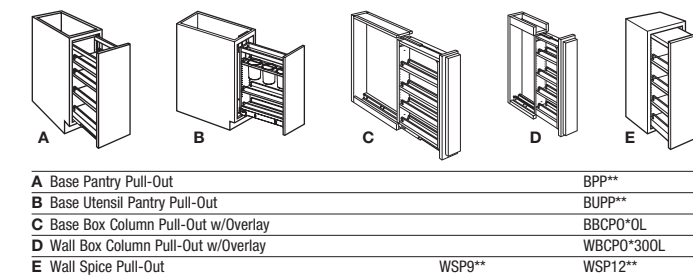

WALL CHINA & WINE CABINETS

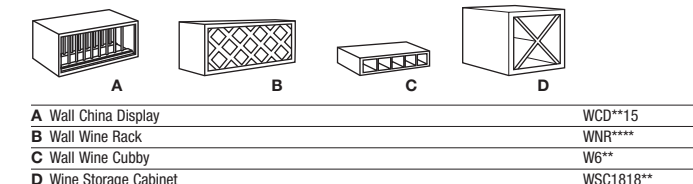

RACKS & SHELVES

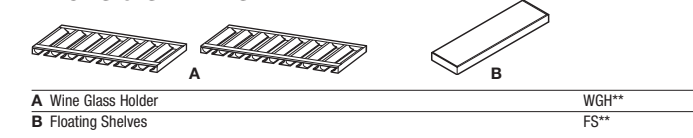

Note: The number of shelves varies with the height. The number of drawers varies with the width. This represents a portion of the entire line. See your kitchen designer for the full line offering.

WALL WOOD HOODS

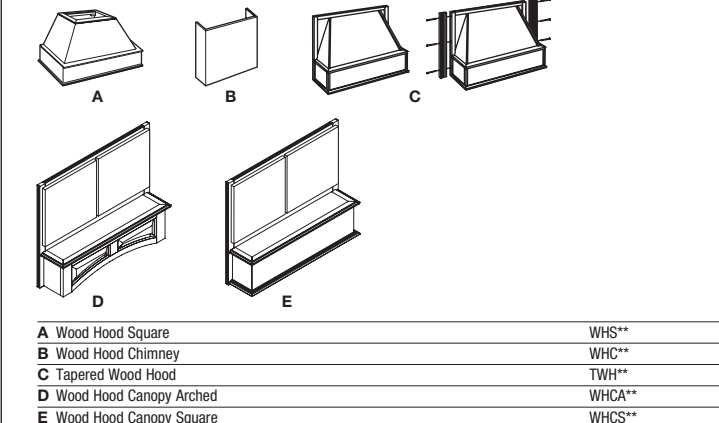

BASE SHELF CABINETS

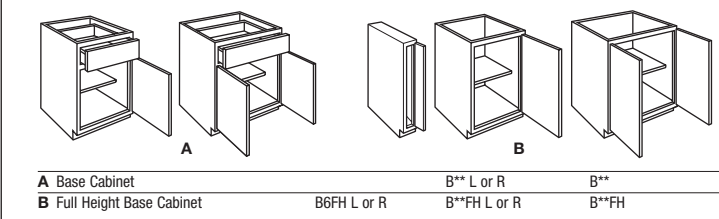

BASE POTS, PANS, & BAKING DISHES CABINETS

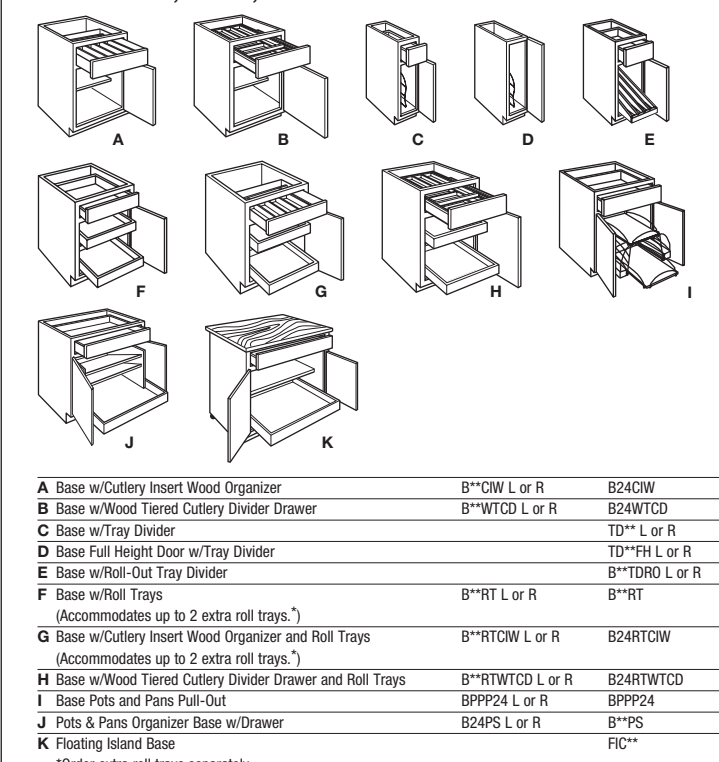

BASE & SINK BASE SUPERCABINET™

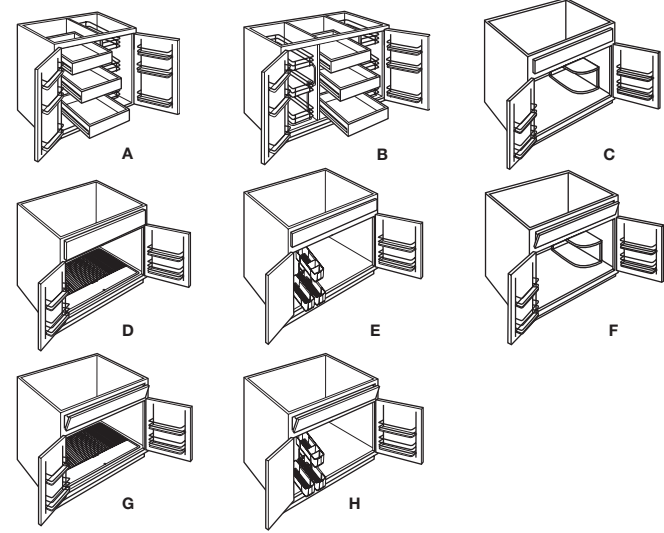

A 30" SuperCabinet™	BSC30RP
B 36" SuperCabinet™	BSC36PRP
C Sink Base Supercabinet™	SB36S
D Sink Base Supercabinet™ w/CabMat™	SB36SCM
E Sink Base Supercabinet™ w/Caddy	SB36SCDY L or R
F Sink Base Supercabinet™ w/Tilt-Out Trays	SB36STS
G Sink Base Supercabinet™ w/Tilt-Out Trays and CabMat™	SB36STSCM
H Sink Base Supercabinet™ w/Tilt-Out Trays and Caddy	SB36STSCDY L or R

SINK BASES

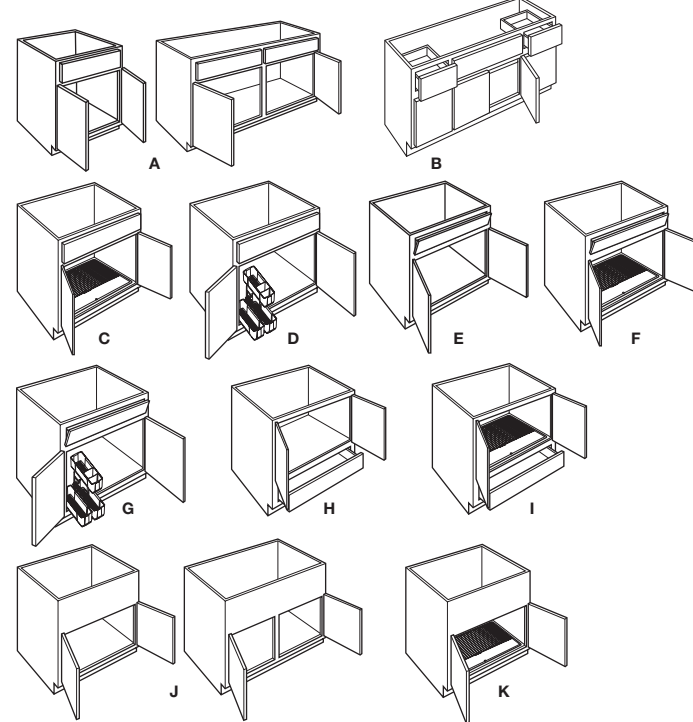

A Sink Base	SB24 L or R	SB**
B Sink Base w/Drawers	2SBD**	
C Sink Base w/CabMat™	SB**CM	
D Sink Base w/Caddy	SB36CDY L or R	
E Sink Base w/Tilt-Out Trays	SB**ST	
F Sink Base w/Tilt-Out Trays and CabMat™	SB**STCM	
G Sink Base w/Tilt-Out Trays and Caddy	SB36STCDY L or R	
H Sink Base w/Drawer Below	SB36D	
I Sink Base w/Drawer Below and CabMat™	SB36DCM	
J Country Sink Base	CNTYSB**	
K Country Sink Base w/CabMat™	CNTYSB**CM	

Note: The number of shelves varies with the height. The number of drawers varies with the width. This represents a portion of the entire line. See your kitchen designer for the full line offering.

CORNER SINK BASES

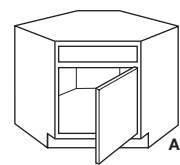

A Angled Corner Sink Base	ACS** L or R	ACS42
---------------------------	--------------	-------

BASE CORNER OPTIONS

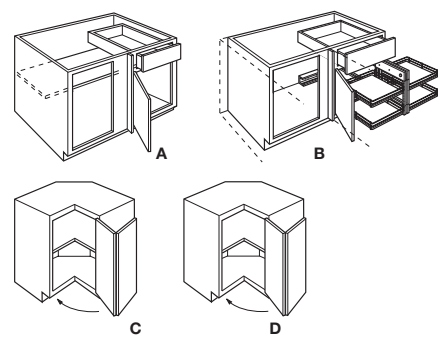

A Base Corner	BC** L or R
B Base Corner w/Pull-Out	BC**PO L or R
C Base Easy Reach	BER** L or R
D Asymmetrical Base Easy Reach	BER*** L or R

BASE LAZY SUSANS

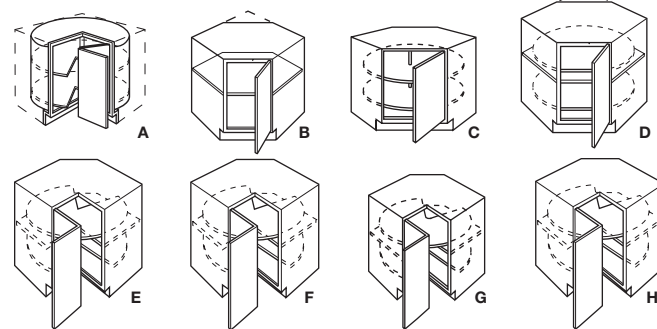

A Base Lazy Susan Corner w/Full Height Center Hinged Door	BLS36 L or R
B Diagonal Base w/Full Height Door	DAB36FS L or R
C Diagonal Base w/Full Height Door and Lazy Susan	DAB36S L or R
D Diagonal Base w/Full Height Door and Super Lazy Susan	DAB36SLS L or R
E Asymmetrical Super Lazy Susan	SLS*** L or R
F Asymmetrical Solid Wood Super Lazy Susan	SLSW*** L or R
G Super Lazy Susan	SLS** L or R
H Solid Wood Super Lazy Susan	SLSW** L or R

BASE END OPTIONS

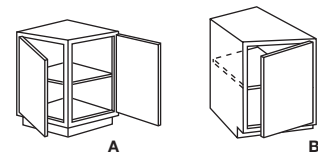

A Base End Cabinet	BEC24
B Base Transition Cabinet	BTC12**

DRAWER BASE CABINETS

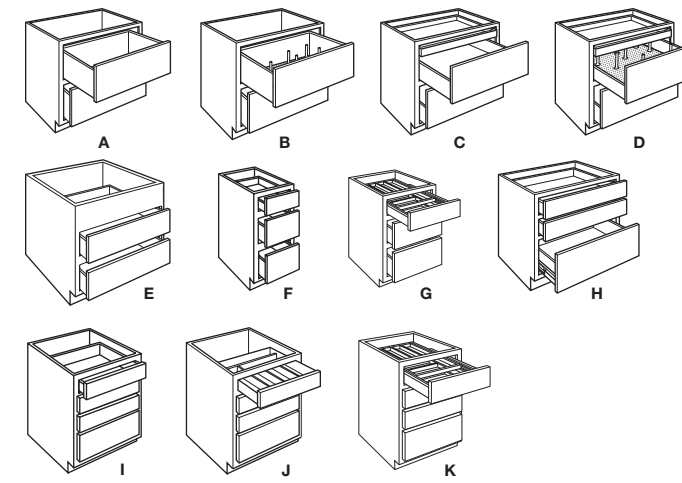

A Two Drawer Base	2DB**
B Two Drawer Base w/Pegged Dish Organizer	2DB36PDO
C Two Drawer Base w/Roll Tray	2DB**RT
D Two Drawer Base w/Roll Tray and Pegged Dish Organizer	2DB36RTPDO
E Two Drawer Base, Drop-In Range	2DB36DR
F Three Drawer Base	3DB**
G Three Drawer Base w/Wood Tiered Cutlery Divider Drawer	3DB**WTCD
H Three Drawer Base w/Deep Drawer	3DB**DD
I Four Drawer Base	4DB**
J Four Drawer Base w/Cutlery Insert Wood Organizer	4DB**CIW
K Four Drawer Base w/Wood Tiered Cutlery Divider Drawer	4DB**WTCD

BASE WASTE CABINETS

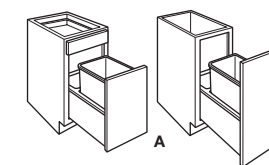

A Base Wastebasket w/Full Height Door	BWB**
	BWB**FH

BASE END OPTIONS

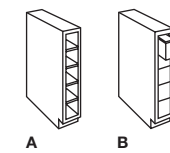

A Base Wine Cubby (Holds 5 bottles.)	BWC6
B Base Spice Cabinet w/Drawers	BSD6

BASE OVEN & MICROWAVE CABINETS

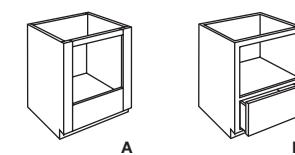

A Base Oven Cabinet	B0**
B Base Microwave Cabinet w/Drawer	BMWD**34

BASE CORNER PENINSULA OPTIONS

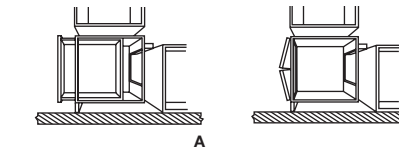

A Base Corner Peninsula w/Shelf and Drawer	BCP24
B Base Corner Peninsula w/Shelf and Full Height Doors	BCP24FH

TALL UTILITY CABINETS / TALL PANTRY PULL-OUT

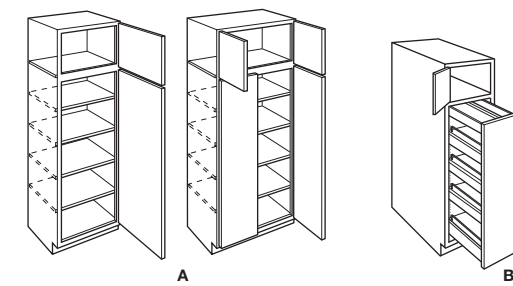

A Utility Cabinets	U**** L or R	U****
B Tall Pantry Pull-Out	TPP****24 L or R	

UTILITIES WITH ROLL TRAYS / UTILITY ORGANIZER

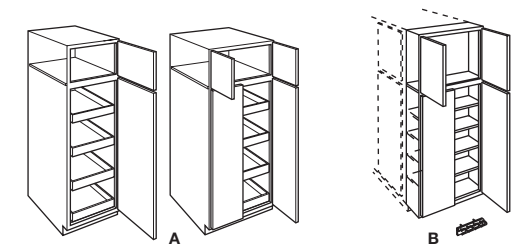

A Utility w/Roll Trays	U12**24RT L or R	U24**24RT L or R	U30**24RT
	U15**24RT L or R	U24**24RT	U33**24RT
	U18**24RT L or R	U27**24RT	U36**24RT
	U21**24RT L or R		
B Utility Organizer Cabinet		UOC24**6	

TALL OVEN & MICROWAVE CABINETS

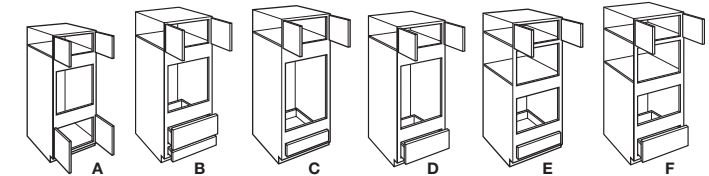

A Single Oven Cabinet	OCS****24
B Single Oven Cabinet w/Deep Drawer	OCS****24DD
C Double Oven Cabinet	OCD****24
D Double Oven Cabinet w/Deep Drawer	OCD****24DD
E Oven Microwave Cabinet	OMC****24
F Oven Microwave Cabinet w/Deep Drawer	OMC****24DD

WALL BOOKCASES WITH VALANCE

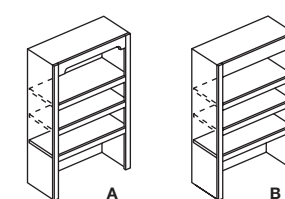

Specify valance type by adding appropriate letters to end of model number. Wall Bookcase w/Valance	W****BC	A with Furniture Valance FV	B with Straight Valance W

Note: The number of shelves varies with the height. The number of drawers varies with the width. This represents a portion of the entire line. See your kitchen designer for the full line offering.

TALL BOOKCASES WITH VALANCE

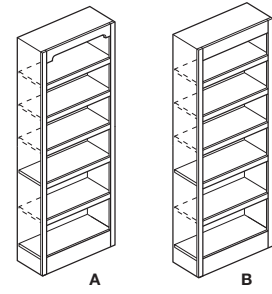

Specify valance type by adding appropriate letters to end of model number.	A with Furniture Valance	B with Straight Valance
Tall Bookcase w/Valance	T****12BC FV	W

BASE OFFICE FURNITURE

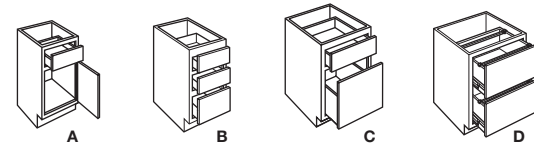

A Desk Door Drawer Base	DDO**29** L or R	DDO**29**
B Desk Drawer Base	DDR**2921	DDR**2924
C Desk File Drawer Base	DFD**2921	DFD**2924
D Desk Double File Drawer Base	DDFD**2921	DDFD**2924

FURNITURE DRAWERS & WOOD TOPS

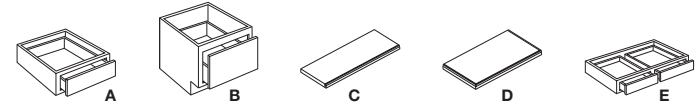

A Furniture Drawers	FD**06.7524	FD**1224
B Furniture Drawer Window Bench		FDWB**1824
C Wood Tops, One Sided	1TWT7221	1TWT7224
D Wood Tops, Three Sided	3TWT**21	3TWT**24
E Under Counter Drawer		UCD**21

VANITY SINK BASES

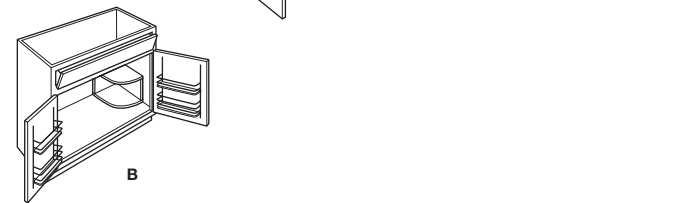
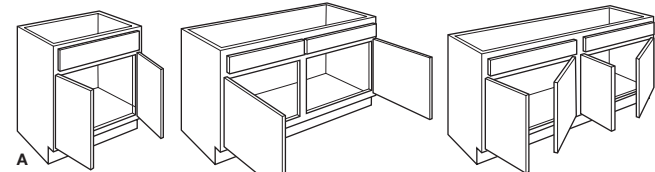

A Vanity Sink Base w/False Panels	VSB24**** L or R	VSB****18 VSB****21
B Vanity Sink Base SuperCabinet™ w/Tilt-Out Trays		VSB**3421ST

VANITY DRAWER BASE CABINETS

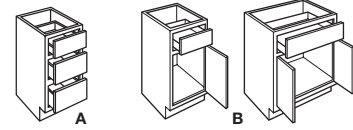

A Vanity Drawer Base		VDB****21
B Vanity Base w/Drawer	VB****21 L or R	VB****21

VANITY PULL-OUT

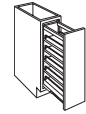

A Vanity Pull-Out		VP93421
--------------------------	--	---------

VANITY SINK DRAWER BASES

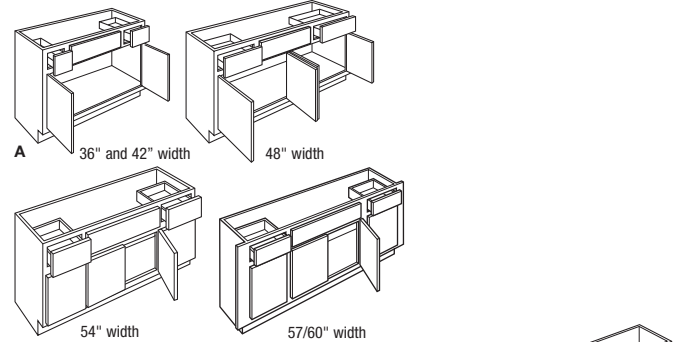

A	36" and 42" width	48" width
B	24" and 30" width	36" width
C	54" width	57/60" width
D	42" and 48" width	60" width

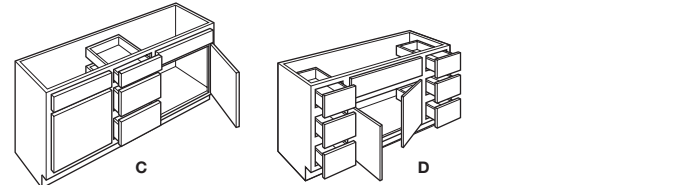

A Vanity Sink Drawer Base	2VSD****21	2VSD54**21FP 2VSD57/60**21FP
B Vanity Sink Drawer Base w/False Panels	VSD****21FP DL or DR	VSD60**21FP
C Vanity Sink Three Drawer Base	VS3D54**21	VS3D60**21
D Vanity Sink Drawer Base w/Six Drawers & False Panel	6VSD****21FP	

LINEN CLOSETS & VANITY UTILITY

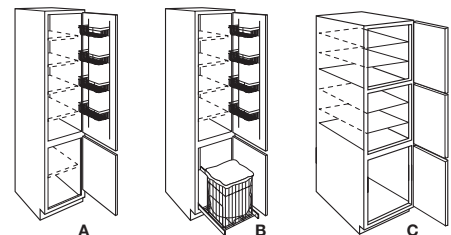

A Linen Closet		LC188421 L or R
B Linen Closet w/Removable Hamper		LCRH188421 L or R
C Vanity Utility		VU188421 L or R

Note: The number of shelves varies with the height. The number of drawers varies with the width. This represents a portion of the entire line. See your kitchen designer for the full line offering.

WALL CABINETS, VANITY MIRROR, & MEDICINE CABINET

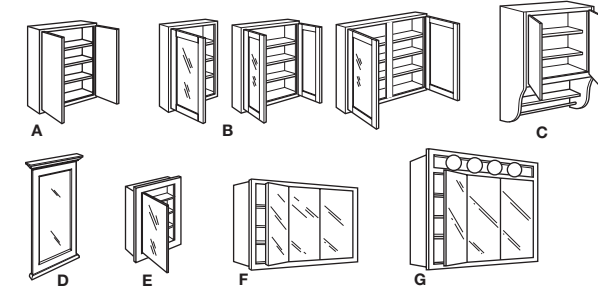

A Vanity Wall Cabinet		W24306
B Vanity Wall Mirror Cabinet	VWM**30 L or R	VWM**30
C Vanity Wall Towel Bar		VWTB24
D Vanity Mirror		VM**35
E Single Door Medicine Cabinet		MC16
F Tri-View Medicine Cabinet		TV**
G Tri-View Medicine Cabinet Lighted w/Chrome Face Plate		TMLC****

PLAIN FILLERS

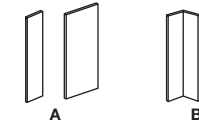

A Filler	F**	TF**	TF***FH
B Corner Filler			CF330

OVERLAY FILLERS

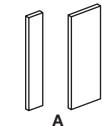

A Overlay Filler		OL**	VOL**
-------------------------	--	------	-------

ORNATE FILLERS

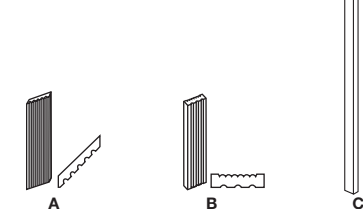

A Angled Fluted/Plain Reversible 3" Filler		BLVDF**	BLVDTF96
B Fluted/Beaded Reversible 3" or 6" Filler		FBF**	TFBF*96
C Space Filler			S96X1*

Note: The number of shelves varies with the height. The number of drawers varies with the width. This represents a portion of the entire line. See your kitchen designer for the full line offering.

BOX COLUMN FILLERS

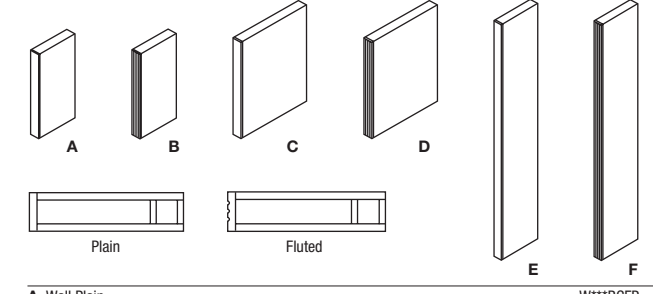

A Wall Plain		W**BCFP
B Wall Fluted		W**BCFF
C Base Plain		B334.527BCFP
D Base Fluted		B334.527BCFF
E Tall Plain	T3**15BCFP	T3**27BCFP
F Tall Fluted	T3**15BCFF	T3**27BCFF

DECORATIVE APPLIANCE PANELS

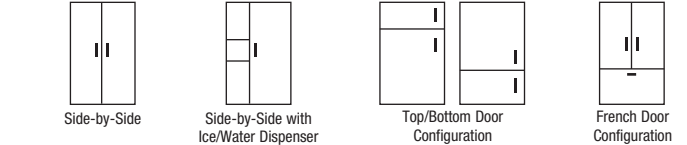

NOTE: Please see designer for complete listing of availability and sizes for customizable decorative appliance panels.

A Custom Panels	DAPNL1/4	DAPNL3/4	DAPNL3/4APP
------------------------	----------	----------	-------------

PANELS & SKINS

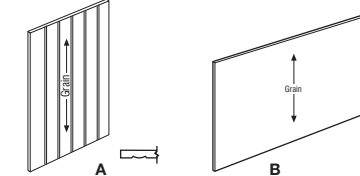

A Wood V-Grooved Panel Skin	BP4834.5VG	BP4896VG
B Cross Grain Veneer Back Panel Skin	BP9634.5CRSGR	BP9648CRSGR

PANELS W/FILLER ATTACHED

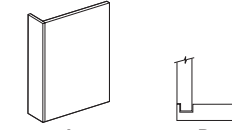

A Panels w/Filler Attached	BEPF1.5LAM	TEP24**F1.5LAM
	BEPF1.5WD	TEP24**F1.5WD
	BEPF3LAM	TEP24**F3LAM
	BEPF3WD	TEP24**F3WD
B Panels w/Filler Attached & Furniture Ends	BEPF1.5FPE	TEP24**F1.5FPE
	BEPF3FPE	TEP24**F3FPE

FINISHING TOUCHES

CROWN MOULDINGS

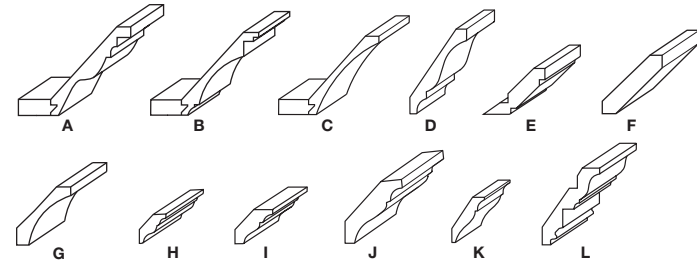

A Classic Tall Crown	CLTCROWN8
B Cornice Tall Crown	COTCROWN8
C Cove Crown	COVECROWN8
D Tall Crown	MTCROWN8
E Shaker Crown	SHKRCRM8
F Large Shaker Crown	LSHAKER8
G Small Cove Crown Moulding	SMCOVECROWN8
H Small Crown	SCM8
I Solid Wood Crown	SWCRM8
J Solid Wood Large Crown	SWLCRM8
K Solid Wood Tall Crown	SWTCRM8
L Solid Wood Victorian Crown	SWVCRM8

MOULDING INSERTS

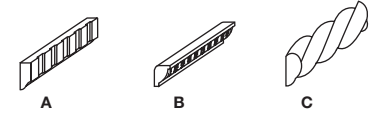

A Dentil	DE8
B Egg & Dart	EGD8
C Rope	RPM8

STARTER MOULDINGS

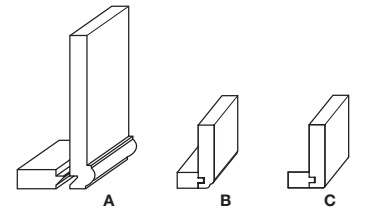

A Soffit Filler Moulding	SFM8
B Starter Moulding	STR8
C Starter Moulding, Shaker	STRS8

ACCENT MOULDINGS

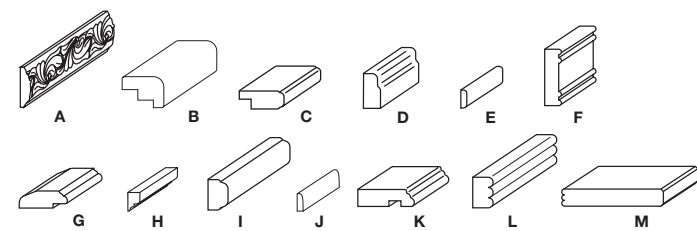

A Acanthus	ACAM
B Back Panel Moulding	BPM8
C Cabinet Panel Edge	CPE8
D Countertop Edge-Traditional	TCM8
E Flat Scribe	SM8
F Library	LBRM
G Mirror Frame	WMF8
H Ogee Edge	OGEEM
I Single Bead Edge	SBE8
J Small Scribe	SSM8
K Soffit Trim	TSTM8
L Triple Bead Edge	TBEM
M Triple Bead Pilaster	TBP8

TOE MOULDINGS

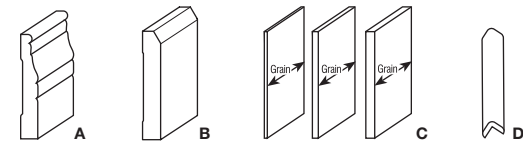

A Baseboard	BBM8
B Baseboard - Shaker	BBMSH8
C Toeboard	TB8WD14
D Toekick Cap	TKC

WINDOW CASING



A Window Casing - Traditional	WCT7
-------------------------------	------

LIGHT RAILS

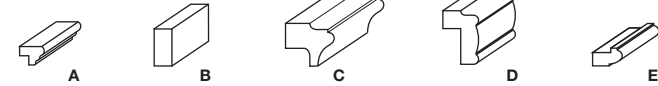

A Cap Moulding	CAPM
B Light Baffle (Square)	LB2
C Small Light Rail Moulding	SMLR
D Light Rail Moulding	LRM
E Valley Forge Moulding	VFR8

CORNER MOULDINGS

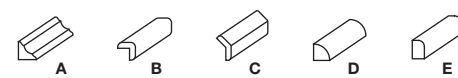

A Inside Corner	ICM8
B Outside Corner	OCM8
C Outside Corner 135°	OC135
D Quarter Round	QRM
E Shoe - Convex Inside Corner	SHM8

VALANCES

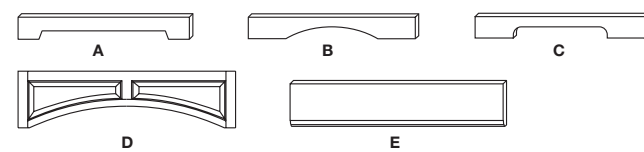

A Angled Furniture Toekick Valance	AVTOE**
B Arched Valance	AV**
C Furniture Valance	FV**
D Raised Panel Arch Valance	RPV**
E Straight Valance	W**

DECORATIVE ORNAMENTS



A Mission Rosette	ROSETTEMIS
B Corner Rosette - Fluted Beaded	FFRC3X3
	BFRC3X3

FINISHING TOUCHES

DECORATIVE SUPPORTS

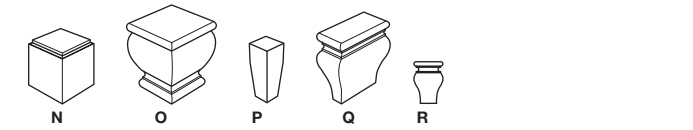
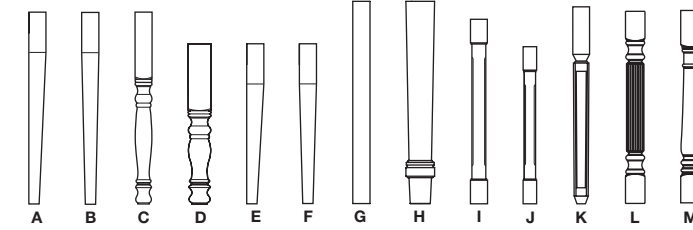

A Bar Leg, 2-Sided	2SBARLEG
B Bar Leg, 4-Sided	4SBARLEG
C English Bar Column	ENGBARCOLUMN
D English Island Column	ENGLISLCOLUMN
E Island Leg, 2-Sided	2SISLLEG
F Island Leg, 4-Sided	4SISLLEG
G Island Leg Straight	ISLEGST
H Island Leg Tapered	ISLEGTPRD
I Metro Bar Column	METBARCOLUMN
J Metro Island Column	METISLCOLUMN
K Mission Leg	DLEGMSSION
L Reed Leg	RDLEG
M Spool Leg	SPLEG
N Large Square Foot	LGSOFOOT
O Lille Foot	LIFOOT
P Tapered Leg	TAPLG
Q Toekick Tulip Foot	TKTLFOOT
R Tulip Foot	TLFOOT

DECORATIVE SPLIT TURNINGS



A End Split Turning	SPRINGEND
B Spool Split Turning	SPRINGSPPOOL**

DECORATIVE CORBELS & SHELF SUPPORTS

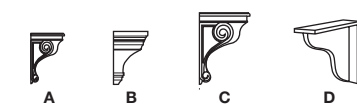

A 9" Small Corbel	SMCORBEL
B 9" Art Corbel	CORBELART9
C 13" Large Corbel	LGCORBEL
D Snack Bar Support	SBS

WALL ACCESSORIES



A Cookbook Rack	CBR
B Tablet Holder	TABLEHLDR

BASE / TALL / VANITY ACCESSORIES

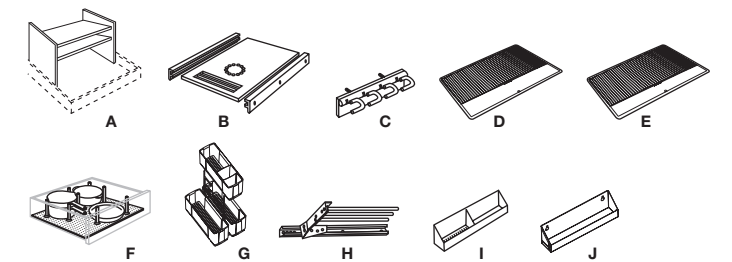

A Base Pan Storage	BPS**
B Bread Box Lid	BBX**
C Broom Clip	BRMCLP
D CabMat™	CABMAT**
E CabMat™ Vanity	CABMATV**
F Pegged Dish Organizer	PDO
G Sink Base Caddy	SBCADDY
H Sliding Towel Rack	STR
I Tilt-Out Trays, Plastic	TOT**
J Tilt-Out Trays, Stainless Steel	TOTSS**

BASE CUTLERY, ORGANIZERS, & DIVIDERS

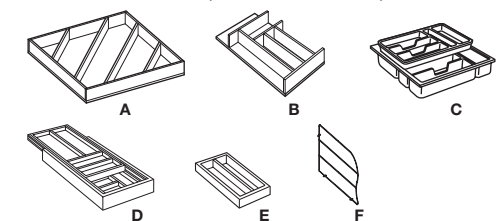

A Cooking Utensil Divider	CUDD**
B Cutlery Insert Wood Organizer	CIW**
C Cutlery Divider, Tiered	TCD**
D Wood Tiered Cutlery Divider Drawer	WTCD**
E Lid Organizer	LO
F Tray Divider Kit	CTDK

ROLL TRAY KITS & SHELVES

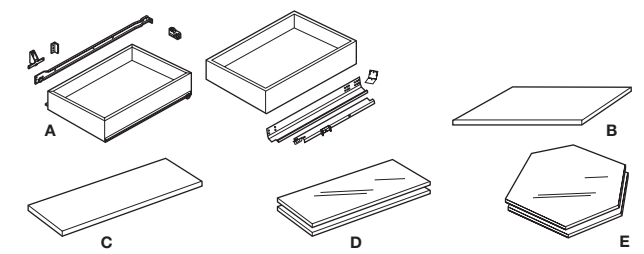

A Roll Tray Kits	RT**
B Exterior Shelf	ES****
C Full Depth Shelves	SK****
D Glass Shelf Kit	GSK****
E Glass Shelf Kit, Diagonal	GSKDW**



LOOKING FOR MORE KEMPER®?

Kemper® Echo™ is a unique line brought to you by Kemper Cabinetry. For over 45 years, Kemper has offered more designer-inspired colors and styles; more wood grain and laminate options; and, more modernly engineered conveniences that capture the visual and practical vibe of the times. With every inch of meticulous workmanship backed by a limited lifetime warranty. For the full Kemper product selection, visit kempercabinets.com.

KEMPER
echo™

Kemper is a certified brand in the Kitchen Cabinet Manufacturers Association (KCMA) Environmental Stewardship Program. The program recognizes companies that demonstrate an ongoing commitment to environmental practices and sustainability.

Styles, product availability and construction may vary slightly from those shown in this catalog due to material availability and/or design evolution. Specifications are subject to change without notice. For more details check with your designer.

Supersedes prior versions.

Product photography and illustrations have been reproduced as accurately as printing technologies permit. To ensure highest satisfaction, we strongly recommend you view an actual sample for best color, wood grain and finish representation.

Front cover image: Warren PureStyle™ Limestone

